



# регуляторы энергии 3

EGO.....	204
DIAMOND.....	205
ROBERTSHAW.....	205
UNITED AUTOMATION.....	205
miscellaneous.....	205



## регуляторы энергии

EGO

## 1-circuit



fig.	volt. (V)	SC (A)	turn direction	shaft $\phi$ (mm)	mounting thread	diagram	Ref. No.
1 380009	230	13	left	6x4.6	M4	ER01	50.57020.010
1 380015	230	13	right	6x4.6	M4	ER01	50.17071.000 50.27021.010 50.57011.010 50.57021.010
1 380019	240	13	right	6x4.6	M4	ER01	50.57071.010
1 380014	400	7	left	6x4.6	M4	ER01	50.57030.010
1 380013	400	7	right	6x4.6	M4	ER01	50.57031.010
2 380036	230	13	right	6x4.6	M12x1	ER01	50.57024.010
2 380035	240	13	left	6x4.6	3/8"-24UNF	ER02	50.59070.048
3 380046	240	13	left	6x4.6	M4	ER02	50.59070.051
4 380935	240	13	right	6x4.6	M4	ER01	50.57071.150
5 380879	240	13	right	5x4	1/8"	ER01	50.52076.070
5 381160	240	13	right	5x4	1/8"	ER01	50.57076.070

Diagrams may be found at the end of the chapter

## 2-circuit

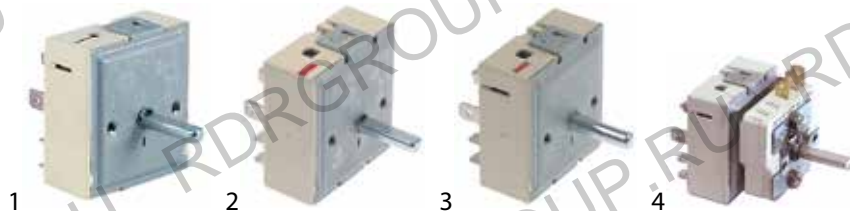

fig.	volt. (V)	SC (A)	turn direction	shaft $\phi$ (mm)	mounting thread	diagram	Ref. No.
1 380027	230	13	right	6x4.6	M4	ER08	50.55021.100
1 380028	400	7	right	6x4.6	M4	ER08	50.55031.100
2 381304	230	13	right	6x4.6	M4		50.55071.100
3 376048 <sup>1</sup>	230	13	right	6,4x4,8	M4	ER08	50.55021.171
4 380024	240	13	right	6x4.6	M4	ER03	50.67079.601

<sup>1</sup>with cable

Diagrams may be found at the end of the chapter



DIAMOND



fig.	volt. (V)	SC (A)	turn direction	shaft ø (mm)	mounting thread	diagram	Ref. No.
1 380038	24	13.5	right	6x4.6	3/8"-24UNF	ER05	35ERE105024V
1 380037	240	13.5	right	6x4.6	3/8"-24UNF	ER05	35ERE101230V
1 380039	400	13.5	right	6x4.6	3/8"-24UNF	ER05	35ERE104400V
2 380032	230	13.5	right	6x4.6	M4	ER04	45ER104C1

Diagrams may be found at the end of the chapter

ROBERTSHAW



fig.	volt. (V)	SC (A)	turn direction	shaft ø (mm)	mounting thread	diagram	Ref. No.
1 380041	240	15	left	6x4.6	8"-32UNC	ER06	INF-240-1165
2 380042	240	15	left	3.5x3.5	8"-32UNC	ER06	INF240TP1211
3 380858	240	15	right	6x4.6	8"-32UNC		—

Diagrams may be found at the end of the chapter

UNITED AUTOMATION



fig.	volt. (V)	SC (A)	turn direction	shaft ø (mm)	mounting thread	equiv. no.	fig.	GEV No.	volt. (V)	SC (A)	turn direction	shaft ø (mm)	mounting thread	equiv. no.
1 381305	240	15	right	6.3	M10x0.75	A13202E	2	381307	240	15	right	6.3	M10x0.75	A14232E
1 381308	240	15	right	5.6x6.4	M10x0.75	A11203E	3	381306	240	17	right	6.3	M10x0.75	A13218E

miscellaneous

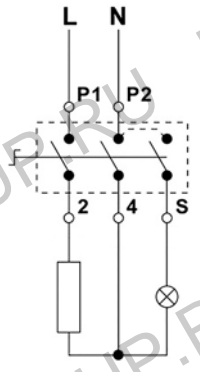

fig.	volt. (V)	SC (A)	turn direction	shaft ø (mm)	mounting thread	diagram	suitable for	Ref. No.
1 380925	230	16	right	6x4.6	M4		Bonamat	6.004.005.003
2 380040	200-250	13	right	4.8x4.1	3/8"-24UNF	ER07	—	—

Diagrams may be found at the end of the chapter



ER01



ER02

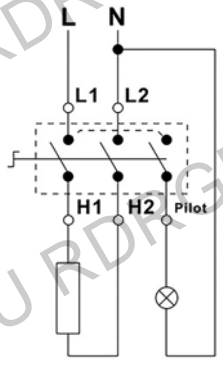

ER03

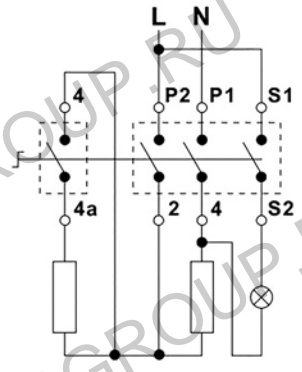

ER04

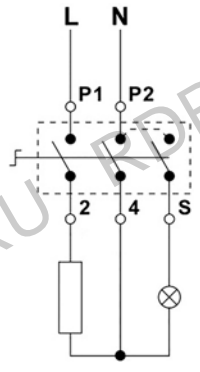

ER05

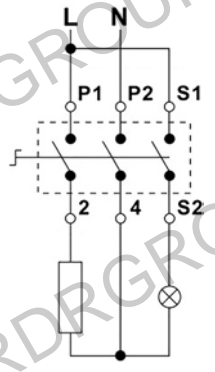

ER06

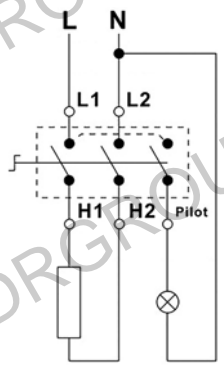

ER07

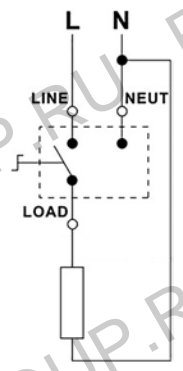

ER08

