



регуляторы и потенциометры

7

| | | | |
|-----------------|-----|-------------------|-----|
| Ambach..... | 368 | Küppersbusch..... | 370 |
| Angelo-Po..... | 368 | Lainox..... | 370 |
| Baron..... | 368 | Lotus..... | 371 |
| Berner..... | 368 | Mareno..... | 371 |
| Bertos..... | 368 | MKN..... | 371 |
| Convotherm..... | 368 | Olis..... | 371 |
| Cookmax..... | 368 | Öztiryakiler..... | 371 |
| EGO..... | 369 | Pizza-Group..... | 371 |
| Electrolux..... | 369 | Rational..... | 371 |
| Fagor..... | 369 | Roller Grill..... | 371 |
| Fimor..... | 369 | Rosinox..... | 372 |
| Foster..... | 369 | Scholl..... | 372 |
| FriFri..... | 369 | Sharp..... | 372 |
| Gico..... | 370 | Sirman..... | 372 |
| Giorik..... | 370 | Tecnoinox..... | 372 |
| Hatco..... | 370 | Therma..... | 372 |
| Henkelman..... | 370 | Zanolli..... | 372 |
| Hoonved..... | 370 | | |
| Hounö..... | 370 | | |
| Krefftt..... | 370 | | |



регуляторы и потенциометры

Ambach



| fig. | description | Ref. No. |
|------|---|------------|
| 1 | 401338 encoder | R65321450 |
| 2 | 347436 operation switch 2 operating positions 2NO sequence 0-1 16 A shaft \varnothing 6x4.6mm shaft L 23 mm | 5003518422 |

Angelo-Po



| fig. | description | Ref. No. |
|------|----------------------|----------|
| 1 | 300230 potentiometer | 32V5580 |

Baron



| fig. | description | Ref. No. |
|------|--|-------------|
| 1 | 401338 encoder | LAR65301450 |
| 2 | 300252 potentiometer 2 operating positions 2NO sequence 0-1 16 A shaft \varnothing 6x4.6mm shaft L 23 mm | CR0737320 |
| 3 | 300188 potentiometer rotation angle 310° oven | BN3103260 |

Berner



| fig. | description | Ref. No. |
|------|--|------------|
| 1 | 300249 operation switch 2 operating positions 2NO switching sequence 0-1 16A shaft \varnothing 6x4,6mm | LP1-100108 |

Bertos



| fig. | description | Ref. No. |
|------|---|----------|
| 1 | 347599 operation switch 2 operating positions 4NO sequence 0-1 16 A shaft \varnothing 6x4.6mm shaft L 23 mm | 38151200 |

Convothem



| fig. | description | Ref. No. |
|------|----------------------|----------|
| 1 | 300098 potentiometer | 5009095 |

Cookmax



| fig. | description | Ref. No. |
|------|-------------------------------|-----------|
| 1 | 401338 encoder | R65301450 |
| 2 | 401677 encoder for microwaves | — |
| 3 | 401678 encoder for microwaves | — |



| fig. | description | Ref. No. |
|------|--|---------------|
| 4 | 401953 PCB hand blenders VORTEX 230V with potentiometer | IB5944010 |
| 5 | 300362 potentiometer 0,1 KOhm rotation angle 270° confectioned cable length 28 mm shaft length 42 mm | IB5940920 |
| 6 | 402057 potentiometer 0,5 KOhm rotation angle 320° shaft length 12,8 mm shaft \varnothing 6 mm 25 W 230 V | X02.13.330.00 |



| fig. | description | Ref. No. |
|------|---|----------|
| 7 | 300227 potentiometer 100 KOhm rotation angle 270° cable length 600mm shaft length 42mm M10 | — |
| 8 | 300231 potentiometer 880 KOhm rotation angle 310° with switch shaft length 8 mm thread M10x0,75 | 0232100 |



EGO

| fig. | description | Ref. No. |
|------|---|--------------|
| 1 | 345331 operation switch 2 operating positions 1NO sequence 0-1 16 A shaft \varnothing 6x4.6mm shaft L 23 mm | 78.94032.507 |
| 2 | 347436 operation switch 2 operating positions 2NO sequence 0-1 16 A shaft \varnothing 6x4.6mm shaft L 23 mm | 78.94032.009 |
| 3 | 347514 operation switch 2 operating positions 2NO sequence 0-1 16 A shaft \varnothing 6x4.6mm shaft L 23 mm | 78.94032.506 |

| fig. | description | Ref. No. |
|------|---|------------------------------|
| 4 | 345119 operation switch 2 operating positions 2NO sequence 0-1 16A shaft \varnothing 6x4.6mm shaft L 23mm | 78.94010.000 |
| 5 | 347599 operation switch 2 operating positions 4NO sequence 0-1 16 A shaft \varnothing 6x4.6mm shaft L 23 mm | 78.94031.519 78.94031.520 |
| 6 | 300252 potentiometer 2 operating positions 2NO sequence 0-1 16 A shaft \varnothing 6x4.6mm shaft L 23 mm | 78.94031.523 |

Electrolux

| fig. | description | Ref. No. |
|------|--|----------|
| 1 | 348104 operation switch 10 operating positions 1NO sequence 0-1-2-3-4-5-6-7-8-9 16 A shaft \varnothing 6x4.6mm | 0C0084 |
| 2 | 345331 operation switch 2 operating positions 1NO sequence 0-1 16 A shaft \varnothing 6x4.6mm shaft L 23 mm | 0G3299 |
| 3 | 347514 operation switch 2 operating positions 2NO sequence 0-1 16 A shaft \varnothing 6x4.6mm shaft L 23 mm | 0G3298 |

| fig. | description | Ref. No. |
|------|--|----------|
| 4 | 346984 operation switch 2 operating positions 4NO switching sequence 0-1 32A shaft \varnothing 6x4,6mm | 0K5063 |
| 5 | 403557 potentiometer 0,6KOhm shaft \varnothing 6mm shaft L 14mm cable length 155mm thread M9 plug type male faston | 0C0974 |
| 6 | 402070 potentiometer 10KOhm rotation angle 360° shaft length 18mm M10x0,75 thread length 9mm | 0G0317 |

Fagor

| fig. | description | Ref. No. |
|------|--|----------|
| 1 | 300198 encoder | 12030862 |
| 2 | 300253 encoder for combi-steamer cable length 125 mm shaft 6x4.6mm shaft L 16 mm | 12024753 |
| 3 | 300254 encoder for combi-steamer cable length 160 mm shaft 6x4.6mm shaft L 16 mm | 12018546 |

| fig. | description | Ref. No. |
|------|---|----------|
| 4 | 401717 potentiometer | 12020078 |
| 5 | 300197 potentiometer 4,7 KOhm rotation angle 360° with switch shaft length 22 mm shaft \varnothing 5,9 mm | 12032034 |
| 6 | 400106 pulser rotation angle 360° shaft \varnothing 6 mm type CPC | 12027410 |

Fimor

| fig. | description | Ref. No. |
|------|----------------|-----------|
| 1 | 403197 encoder | 200001118 |

Foster

| fig. | description | Ref. No. |
|------|----------------------------------|-----------|
| 1 | 403521 encoder shaft length 15mm | 00-555396 |

FriFri

| fig. | description | Ref. No. |
|------|--|----------|
| 1 | 400849 encoder rotation angle 360° for fryer cable length 300 mm shaft L 214 mm thread M10 | 101336 |



Gico



| fig. | description | Ref. No. |
|------|--|----------|
| 1 | operation switch 2 operating positions 2NO sequence 0-1 16A shaft ø 6x4,6mm shaft L 23mm | — |

Giorik



| fig. | description | Ref. No. |
|------|--|----------|
| 1 | encoder | 6010102 |
| 2 | potentiometer 4,7 KOhm rotation angle 310 ° cable length 650 mm shaft length 20 mm | 6010097 |

Hatco



| fig. | description | Ref. No. |
|------|--|---------------|
| 1 | potentiometer 0,5 KOhm rotation angle 320 ° shaft length 12,8 mm shaft ø 6 mm 25 W 230 V | X02.13.330.00 |

Henkelman



| fig. | description | Ref. No. |
|------|---|----------|
| 1 | potentiometer 880 KOhm rotation angle 310 ° with switch shaft length 8 mm thread M10x0,75 | 0232100 |

Hoonved



| fig. | description | Ref. No. |
|------|---|----------|
| 1 | encoder rotation angle 135 ° cycle shaft length 5 mm shaft ø 6 mm ø 26 mm | 34908 |

Hounö



| fig. | description | Ref. No. |
|------|---|----------|
| 1 | encoder cable length 90mm shaft 6mm shaft length 10mm | 20900026 |

Krefft



| fig. | description | Ref. No. |
|------|--|-------------|
| 1 | potentiometer 5 KOhm | 76-30400150 |
| 2 | potentiometer 5 KOhm rotation angle 310 ° shaft length 35 mm shaft ø 6 mm | 76-30400151 |
| 3 | potentiometer 5,2 KOhm rotation angle 300 ° with switch shaft length 18 mm thread M10x0,75 | 76-30400268 |



| fig. | description | Ref. No. |
|------|---|-------------|
| 4 | pulser rotation angle 360 ° shaft ø 6 mm type CPC | 76-88171303 |

Küppersbusch



| fig. | description | Ref. No. |
|------|----------------------------|----------|
| 1 | potentiometer encoder KOhm | 189009 |

Lainox

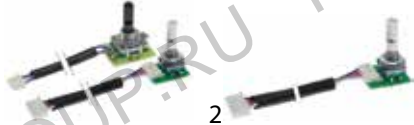

| fig. | description | Ref. No. |
|------|--|-------------|
| 1 | encoder | LAR65301450 |
| 2 | encoder cable length 200mm shaft 6x4,6mm shaft length 18mm | LAR65301941 |

encoders and potentiometers



Lotus



| fig. | description | Ref. No. |
|------|--|-----------|
| 1 | operation switch 2 operating positions 2NO sequence 0-1 16 A shaft \varnothing 6x4.6mm shaft L 23 mm | 537023400 |

Mareno



| fig. | description | Ref. No. |
|------|---|-----------|
| 1 | potentiometer 2 operating positions 2NO sequence 0-1 16 A shaft \varnothing 6x4.6mm shaft L 23 mm | CR0737320 |

MKN



| fig. | description | Ref. No. |
|------|---|----------|
| 1 | operation switch 16 operating positions 3NO switching sequence 0-16 16A shaft \varnothing 6x4,6mm | 203894 |
| 2 | potentiometer with momentary function | 203733 |

Olis



| fig. | description | Ref. No. |
|------|--|-----------|
| 1 | potentiometer rotation angle 310° oven | BN3103260 |

Öztiryakiler



| fig. | description | Ref. No. |
|------|--|---------------|
| 1 | potentiometer 2,5KOhm cable length 130mm L 44mm \varnothing 22,5mm | 6229.00034.09 |

Pizza-Group



| fig. | description | Ref. No. |
|------|---|------------|
| 1 | potentiometer 10KOhm shaft length 10mm M10 shaft \varnothing 6mm 2W type WTH118-1A \varnothing 27,5mm | A96ZN00084 |

Rational



| fig. | description | Ref. No. |
|------|--|-----------|
| 1 | encoder | 40.00.404 |
| 2 | potentiometer 4,7 KOhm rotation angle 360° with switch shaft length 22 mm shaft \varnothing 5,9 mm | 40.00.464 |
| 3 | potentiometer 5 KOhm | 3040.0150 |



| fig. | description | Ref. No. |
|------|---|-----------|
| 4 | potentiometer 5 KOhm rotation angle 310° shaft length 35 mm shaft \varnothing 6 mm | 3040.0151 |
| 5 | potentiometer 5,2 KOhm rotation angle 300° with switch shaft length 18 mm thread M10x0,75 | 3040.0268 |
| 6 | pulsar rotation angle 360° shaft \varnothing 6 mm type CPC | 8817.1303 |

Roller Grill



| fig. | description | Ref. No. |
|------|------------------------|----------|
| 1 | potentiometer 0,5 KOhm | A04005 |



Rosinox



| fig. | description | Ref. No. |
|------|---|------------|
| 1 | 401338 encoder | RX94814233 |
| 2 | 403273 encoder rotation angle 135 ° cycle shaft length 5 mm shaft ø 6 mm ø 26 mm | RX94813831 |
| 3 | 345119 operation switch 2 operating positions 2NO sequence 0-1 16A shaft ø 6x4,6mm shaft L 23mm | RX94814321 |



| fig. | description | Ref. No. |
|------|--|------------|
| 4 | 300247 potentiometer 2,2KOhm rotation angle 270° cable length 150mm shaft length 16mm M10x0,75 | RX94050333 |

Scholl

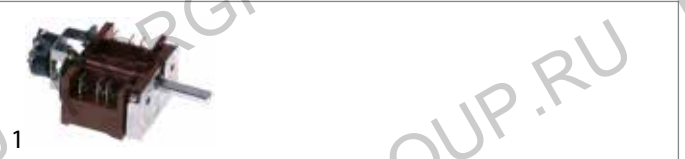

| fig. | description | Ref. No. |
|------|---|----------|
| 1 | 345119 operation switch 2 operating positions 2NO sequence 0-1 16A shaft ø 6x4,6mm shaft L 23mm | 94010000 |

Sharp



| fig. | description | Ref. No. |
|------|-------------------------------|----------------|
| 1 | 401677 encoder for microwaves | DPWBFC373WRKZ1 |
| 2 | 401678 encoder for microwaves | RVR-BA018WRE0 |

Sirman



| fig. | description | Ref. No. |
|------|---|-----------|
| 1 | 401953 PCB hand blenders VORTEX 230V with potentiometer | IB5944010 |
| 2 | 300362 potentiometer 0,1 KOhm rotation angle 270 ° confecti- oned cable length 28 mm shaft length 42 mm | IB5940920 |
| 3 | 300227 potentiometer 100 KOhm rotation angle 270° cable length 600mm shaft length 42mm M10 | IB5940011 |

Tecnoinox



| fig. | description | Ref. No. |
|------|---|------------|
| 1 | 345636 operation switch 2 operating positions 4NO sequence 0-1 16 A shaft ø 6x4,6mm shaft L 23 mm | RC01028000 |

Therma



| fig. | description | Ref. No. |
|------|--|----------|
| 1 | 346984 operation switch 2 operating positions 4NO switching sequence 0-1 32A shaft ø 6x4,6mm | 0K5063 |
| 2 | 402070 potentiometer 10KOhm rotation angle 360° shaft length 18mm M10x0,75 thread length 9mm | 0G0317 |

Zanolli



| fig. | description | Ref. No. |
|------|----------------------------------|----------|
| 1 | 300189 potentiometer encoderKOhm | ELET0200 |

encoders and potentiometers