

POS.	CODE	PIECES	DESCRIPTION
1	R09200230	1	DOOR HANDLE
2	R10100110	1	PRONG FLANGE
3	R10201190	1	LOWER DOOR HINGE
4	R10201290	1	UPPER DOOR HINGE
5	R10207610	1	DOOR
6	R10208290	1	FRONT LOWER DOOR PANEL CATCH
7	R10208300	1	FRONT UPPER DOOR PANEL CATCH
8	R10208320	1	FRONT DOOR PANEL
9	R10400150	2	LIGHT PROTECTION
10	R10401710	1	WASHER FOR UPPER DOOR HINGE
11	R10405470	1	INNER DOOR PANEL
12	R10456040	1	LOWER HINGE FOR FRONT DOOR PANEL
13	R10456050	1	UPPER HINGE FOR FRONT DOOR PANEL
14	R58002150	1	HINGE PIN
15	R58002160	1	DOOR HANDLE PRONG PIN
16	R58002760	1	DOOR HANDLE PRONG COUPLER
17	R58003240	1	DOOR HANDLE BUTTON ROD
18	R58004050	1	NUT FOR UPPER DOOR HINGE
19	R58004270	1	DOOR HANDLE SPACER

POS.	CODE	PIECES	DESCRIPTION
20	R58004830	1	RING NUT M18x1
21	R58005050	1	DOOR HANDLE PRONG
22	R58005340	1	DOOR HANDLE LOWER INSULATION WASHER
23	R58005350	1	DOOR HANDLE UPPER INSULATION WASHER
24	R61620012	1	DOOR HANDLE CATCH SPRING
25	R61620041	1	DOOR HANDLE BUTTON SPRING
26	R65270020	2	LIGHT 20W 12V G4
27	R65270400	2	LIGHT SOCKET
28	R69015000	1	DOOR HANDLE ASSEMBLY
29	R69031190	1	DOOR HANDLE PUSH BUTTON
30	R70040200	2	GLASS GASKET
31	R70040800	2	LIGHT PROTECTION GASKET
32	R70042020	1	DOOR GASKET
33	R71030120	1	DOOR GLASS

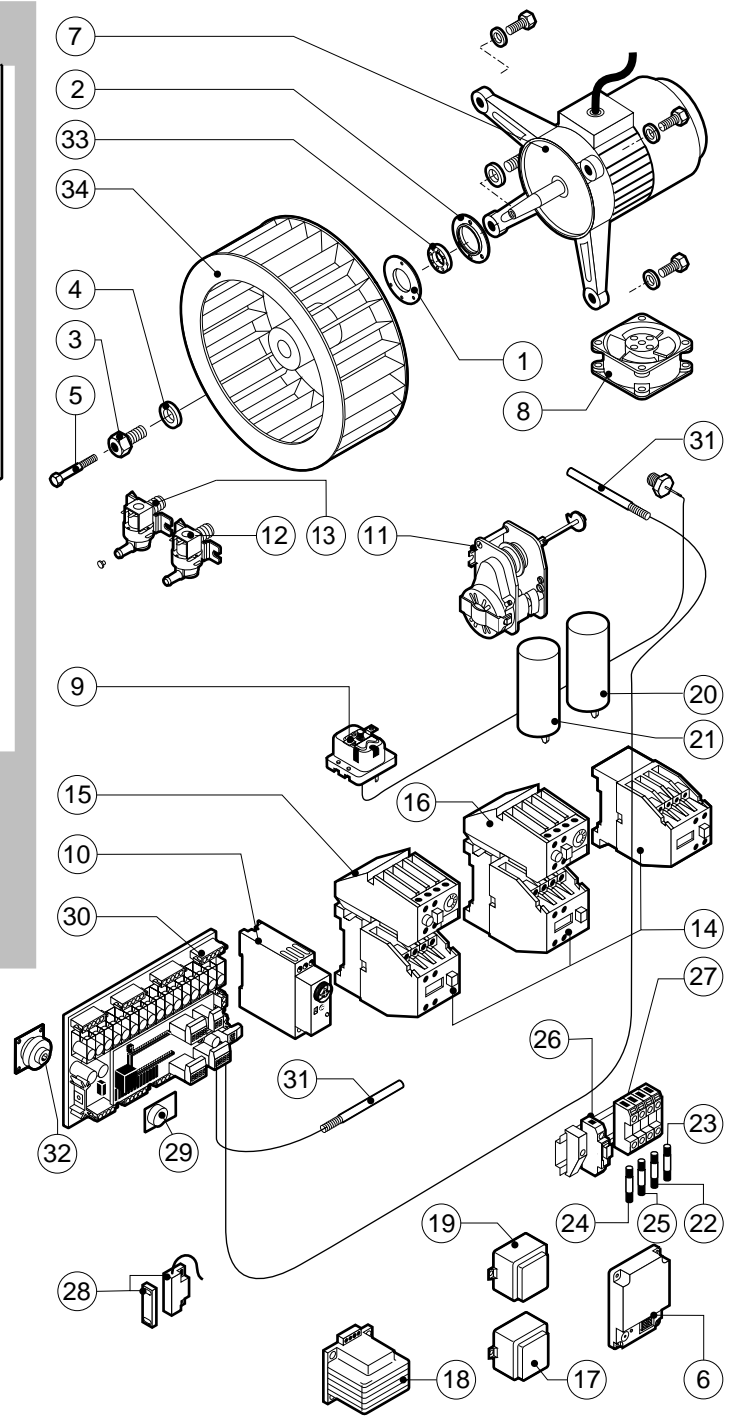
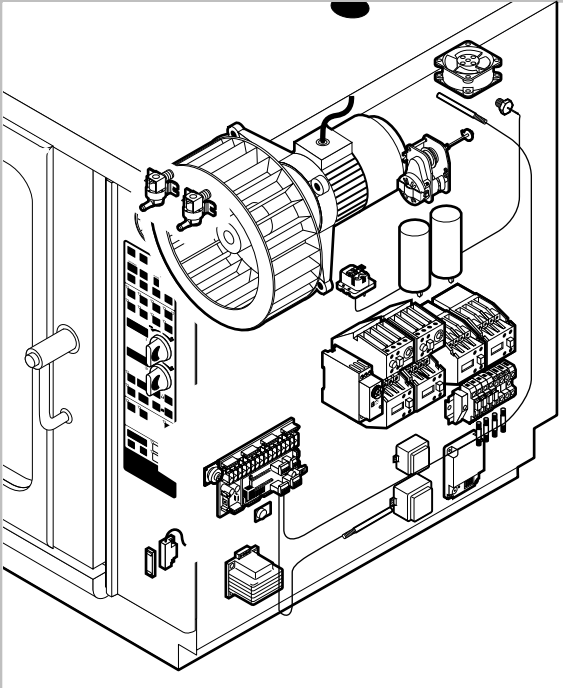

POS.	CODE	PIECES	DESCRIPTION
1	R58003840	1	MOTOR GASKET BRASS FLANGE
2	R58003850	1	MOTOR GASKET BRASS COUNTER FLANGE
3	R58004000	1	FAN SCREW M12x1.5 SX
4	R58004010	1	FAN WASHER Ø 30/12.5
5	R61020562	1	FAN SCREW TE A2 M6x55
6	R63060080	1	BURNER IGNITION PANEL WR 50A72-214
7	R65040031	1	MOTOR HP 1/0.3 KIT
8	R65060010	1	COMPONENTS VENTILATION MOTOR Ø 80
9	R65070070	1	CHAMBER SAFETY THERMOSTAT
10	R65090450	1	IGNITION DELAY TIMER
11	R65095000	1	DAMPER SYSTEM
12	R65110010	1	SOLENOID VALVE 220V 50HZ
13	R65115040	1	SOLENOID VALVE 220V 50HZ WITH FLOW REDUCER
14	R65140150	4	CONTACTOR 3TF4011-OAUO 240V
15	R65160120	1	THERMIC PROTECTION 3UA5000-1C 1.6-2.5A
16	R65160130	1	THERMIC PROTECTION 3UA5000-1F 3.2-5A
17	R65180410	1	TRANSFORMER 16VA
18	R65180430	1	TRANSFORMER 40VA
19	R65180650	1	TRANSFORMER 23VA

POS.	CODE	PIECES	DESCRIPTION
20	R65190030	1	CAPACITOR 16 µF
21	R65190090	1	CAPACITOR 12.5 µF
22	R65200086	1	FUSE 0.125A (T)
23	R65200200	1	FUSE 2A
24	R65200320	1	FUSE 0.2A (T)
25	R65200350	1	FUSE 0.4A (T)
26	R65210020	4	FUSE CARRIER
27	R65220090	1	TERMINAL BOARD
28	R65265100	1	DOOR SWITCH
29	R65300670	1	CLOCK P.C. BOARD
30	R65300730	1	RELAYS P.C. BOARD
31	R65325000	2	PROBE PT100
32	R65330040	1	BUZZER
33	R70020050	1	MOTOR GASKET
34	R75400290	1	FAN Ø 300x120/20 50HZ P.D. KIT

