

POS.	CODE	PIECES	DESCRIPTION
1	R03200970	1	DOOR LOCK REAR FLANGE
2	R10201330	1	LOWER DOOR HINGE WITH RETAINER
3	R10202950	1	LOWER DOOR ROD
4	R10202960	1	UPPER DOOR ROD
5	R10207680	2	DOOR ROD ADJUSTABLE PLATE
6	R10208290	1	FRONT LOWER DOOR PANEL CATCH
7	R10208300	1	FRONT UPPER DOOR PANEL CATCH
8	R10208350	1	FRONT DOOR PANEL
9	R10213720	1	DOOR
10	R10400150	2	LIGHT PROTECTION
11	R10411350	1	LOWER SQUARE FOR DOOR ROD
12	R10411360	1	UPPER SQUARE FOR DOOR ROD
13	R10413290	1	UPPER DOOR HINGE
14	R10456040	2	LOWER HINGE FOR FRONT DOOR PANEL
15	R10456050	1	UPPER HINGE FOR FRONT DOOR PANEL
16	R10458910	1	INNER DOOR PANEL
17	R58002150	1	HINGE PIN
18	R58002540	1	DOOR PIVOT SUNK KEY
19	R58002550	1	DOOR RETAINER GUIDE SHOE

POS.	CODE	PIECES	DESCRIPTION
20	R58002560	1	SCREW FOR LOWER DOOR HINGE
21	R58002570	1	WASHER Ø 30/15x3
22	R58003180	1	DOOR HANDLE PIN
23	R58003450	1	DOOR HANDLE
24	R58004050	1	NUT FOR UPPER DOOR HINGE
25	R58004781	1	DOOR HANDLE HOOK
26	R61040272	1	DOOR HANDLE HOOK SCREW
27	R61090052	1	GRUB SCREW M6x16
28	R61100262	1	GRUB SCREW M8x20
29	R61420021	1	ELASTIC WASHER
30	R61620091	16	BELLEVILLE WASHER Ø 14/6.4
31	R65270020	2	LIGHT 20W 12V G4
32	R65270400	2	LIGHT SOCKET
33	R69015050	1	DOOR HANDLE ASSEMBLY
34	R70040200	4	GLASS GASKET
35	R70040800	2	LIGHT PROTECTION GASKET
36	R70042160	1	DOOR GASKET
37	R71030120	2	DOOR GLASS

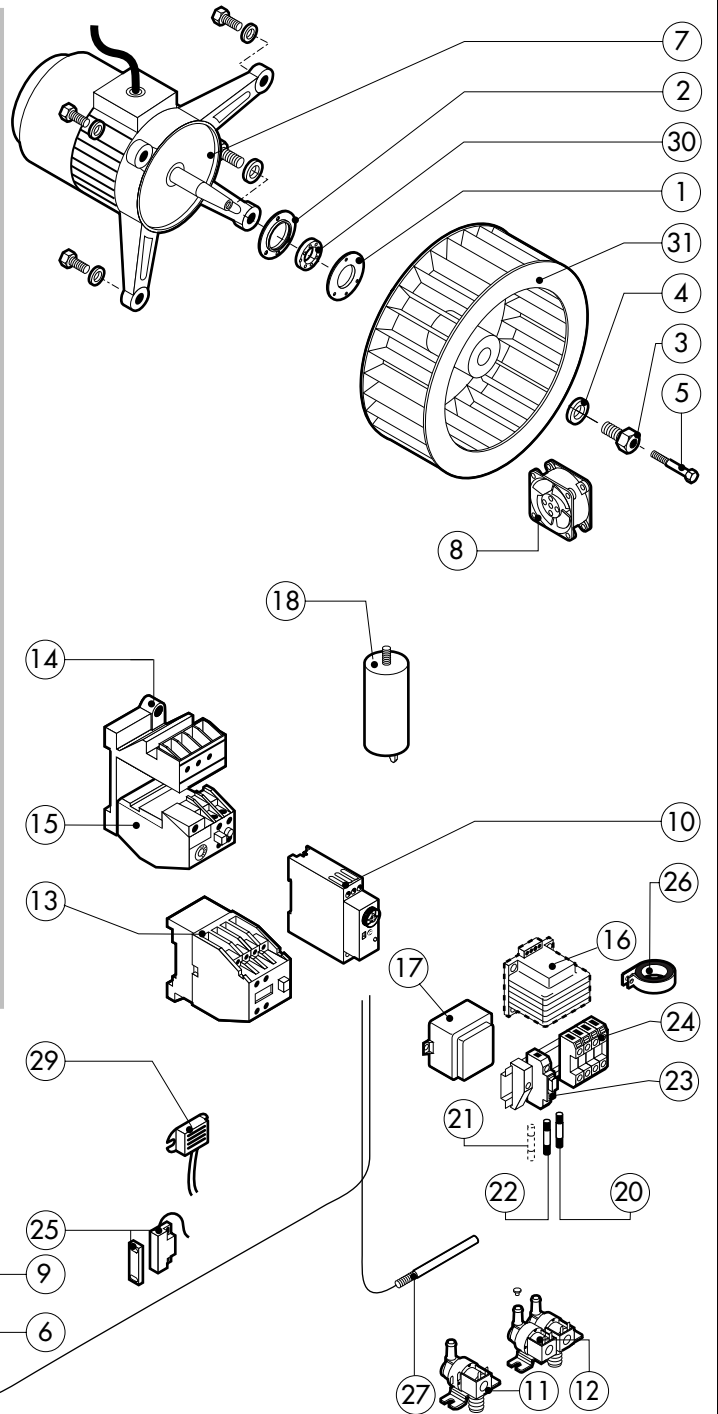
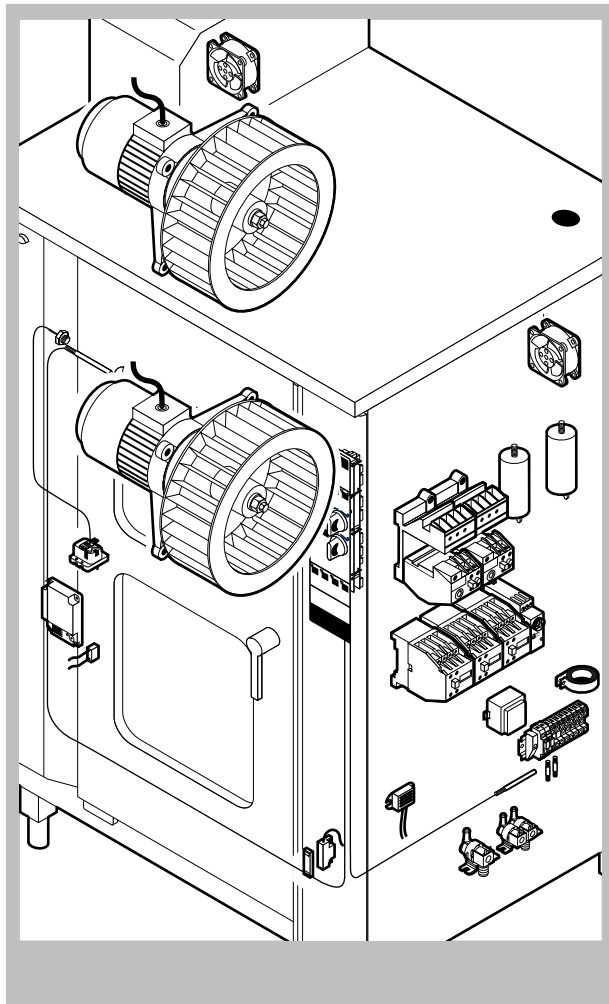

POS.	CODE	PIECES	DESCRIPTION
1	R58003840	2	MOTOR GASKET BRASS FLANGE
2	R58003850	2	MOTOR GASKET BRASS COUNTER FLANGE
3	R58004000	2	FAN SCREW M12x1.5 SX
4	R58004010	2	FAN WASHER Ø 30/12.5
5	R61020562	2	FAN SCREW TE A2 M6x55
6	R63060080	1	BURNER IGNITION PANEL WR50A72-214
7	R65040041	1	MOTOR HP 1 KIT
8	R65060050	1	COMPONENTS VENTILATION MOTOR Ø 120
9	R65070070	1	CHAMBER SAFETY THERMOSTAT
10	R65090450	2	S.GENERATOR DRAIN
11	R65110010	1	SOLENOID VALVE 220V 50HZ
12	R65115000	1	SOLENOID VALVE 220V 50HZ WITH FLOW REDUCER
13	R65140150	3	CONTACTOR 3TF4011-OAUO 240V
14	R65160050	2	THERMIC SWITCH SUPPORT 3UX1418
15	R65160130	2	THERMIC PROTECTION 3UA5000-1F 3.2-5A
16	R65180430	1	TRANSFORMER 40VA
17	R65180650	1	TRANSFORMER 23VA
18	R65190030	2	CAPACITOR 16 µF
19	R65190200	1	INTERFERENCE SUPPRESSOR

POS.	CODE	PIECES	DESCRIPTION
20	R65200200	1	FUSE 2A
21	R65200320	1	FUSE 0.2A (T)
22	R65200350	1	FUSE 0.4A (T)
23	R65210020	3	FUSE CARRIER
24	R65220090	1	TERMINAL BOARD
25	R65265100	1	DOOR SWITCH
26	R65280450	1	FERRITE
27	R65325000	1	PROBE PT100
28	R65325020	1	PROBE PT100 5m
29	R65330020	1	BUZZER
30	R70020050	2	MOTOR GASKET
31	R75400380	2	FAN Ø 350x120/24 50HZ P.D. KIT

